

YZ 107 PHILIPS, ...

INTERRUPTOR BIPOLAR 8/128A-250V~
FIJACION ESPECIAL C.I.. PASO 11,5mm. PINES PARA C.I.

YZ 108 SONY, ...

INTERRUPTOR BIPOLAR 4/128A-250V~
FIJACION ESPECIAL C.I. PASO 14,5mm. PINES PARA C.I.

YZ 191 SONY, SABA, ...

INTERRUPTOR BIPOLAR 4A-250V.
PINES PARA C.I. COTAS DE FIJACION 15 mm.

YZ 109 SHARP, SANYO, ...

INTERRUPTOR BIPOLAR 5/80A-250V~
COTAS DE FIJACION 25mm. PINES PARA CABLES.

YZ 121 PHILIPS, ...

INTERRUPTOR BIPOLAR 8/128A-250V~
FIJACION ESPECIAL C.I. PASO 20mm. PINES PARA C.I.

YZ 110

INTERRUPTOR UNIPOLAR 5/80A-250V
COTAS DE FIJACION 20mm. PINES PARA C.I.

YZ 216 PHILIPS MD2

INTERRUPTOR BIPOLAR 8/128A-250V CA.
PINES C.I. FIJACION C.I.

YZ 111 ITT, SABA, ...

INTERRUPTOR BIPOLAR 5/80A-250V~
FIJACION ESPECIAL C.I. PASO 12,5mm. PINES PARA C.I.

YZ 123 PHILIPS, ...

INTERRUPTOR BIPOLAR 5/80A-250V~
FIJACION ESPECIAL C.I. PASO 18mm. PINES PARA SOLDAR

YZ 194 PHILIPS, ...

INTERRUPTOR BIPOLAR 4A-250V~
FIJACION ESPECIAL C.I. PASO 15 mm. PINES PARA C.I.
PHILIPS. CHASIS CP110.

YZ 170 ITT, SABA, THOMSON, ...

INTERRUPTOR BIPOLAR 4A-250V.
CONTACTO AUXILIAR. COTAS DE FIJACION 15 mm C.I.

YZ 210 ITT, THOMSON, SALORA, ...

INTERRUPTOR BIPOLAR 4-250V.
CONTACTO AUXILIAR M/D.
COTAS DE FIJACION 15mm C.I.

YZ 135 PHILIPS, ITT, ...

INTERRUPTOR BIPOLAR 4A-250V.
PINES PARA SOLDAR CABLES. COTAS DE FIJACION 22mm

YZ 171 THOMSON, ...

INTERRUPTOR BIPOLAR 4A-250V.
CONTACTO AUXILIAR. COTAS DE FIJACION 18 mm.

YZ 174 PHILIPS, ...

INTERRUPTOR BIPOLAR 4A/250V.
CONTACTO AUXILIAR M/D.,
PINES PARA SOLDAR CABLES. COTAS DE FIJACION 23 mm.

YZ 115 PHILIPS, THOMSON, ...

INTERRUPTOR BIPOLAR 2,5A-250V.
PINES PARA SOLDAR CABLES. COTAS DE FIJACION 18mm

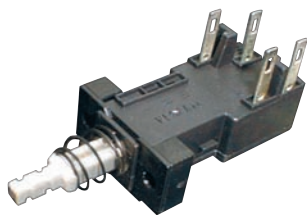

YZ 116 PHILIPS, THOMSON, ...

INTERRUPTOR BIPOLAR 2,5A-250V.
CONTACTO AUXILIAR M/D 1A/24V.
PINES PARA SOLDAR CABLES. COTAS DE FIJACION 18mm



YZ 118 GRUNDIG, PHILIPS, ...

INTERRUPTOR BIPOLAR 2,5A-250V.
CONTACTO AUXILIAR M/D 1A/24V.
PINES PARA C.I.. COTAS DE FIJACION 18mm

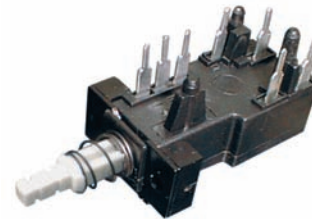

YZ 117 PHILIPS, THOMSON, ...

INTERRUPTOR BIPOLAR 2,5A-250V.
PINES PARA C.I.. COTAS DE FIJACION 18mm

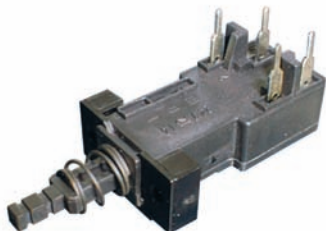

YZ 125 BLAUPUNKT, IMPERIAL, ...

INTERRUPTOR BIPOLAR 2,5A-250V.
PINES PARA C.I.. COTAS DE FIJACION 20mm

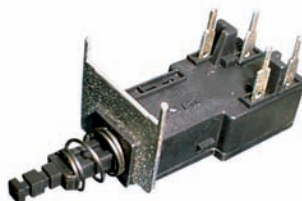

YZ 126 BLAUPUNKT, ITT, ...

INTERRUPTOR BIPOLAR 2,5A-250V.
CONTACTO AUXILIAR M/D 1A/24V
PINES PARA C.I.. COTAS DE FIJACION 20mm

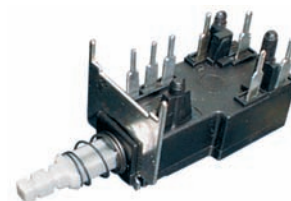

YZ 130 TELEFUNKEN, ITT, ...

INTERRUPTOR BIPOLAR 2,5A-250V.
CONTACTO AUXILIAR M/D 1A-24V
PINES PARA C.I.. COTAS DE FIJACION 23mm

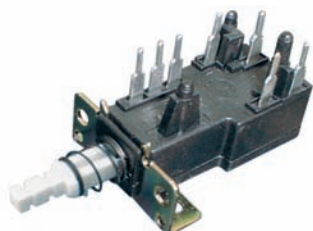

YZ 122 SANYO, ...

INTERRUPTOR BIPOLAR 2,5A-250V.
CONTACTO AUXILIAR M/D 1A-24V
PINES PARA C.I.. COTAS DE FIJACION 18,9mm

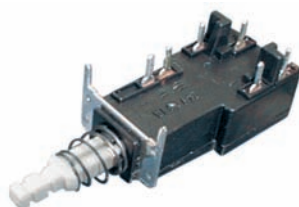

YZ 134 SONY, ...

INTERRUPTOR BIPOLAR 2,5A-250V.
CONTACTO AUXILIAR M/D 1A-24V
PINES PARA C.I.. COTAS DE FIJACION 26,5mm

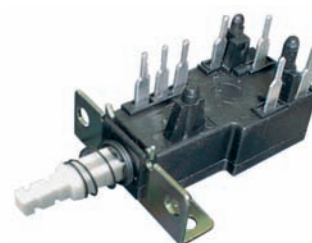

YZ 120 PHILIPS, ...

INTERRUPTOR BIPOLAR 250VCA-5A.
PINES PARA C.I.. FIJACION C.I.

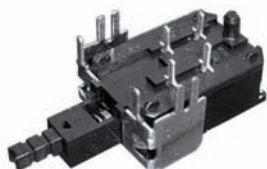

YZ 119 SANYO, THOMSON, ...

INTERRUPTOR BIPOLAR S-95.
6/120A-250V CA. FIJACION C.I.



YZ 197

INTERRUPTOR BIPOLAR 4/100A-250V-
CONTACTO AUXILIAR. FIJACION ESPECIAL.
DESCONEXION POR BOBINA 8/17V D.C.



YZ 145 INFORMATICA

INTERRUPTOR BIPOLAR. 4/128A-250V CA.
COTAS DE FIJACION 20 mm.

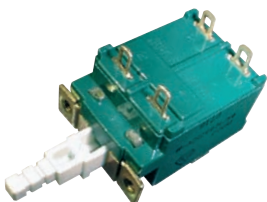

YZ 192 SAMSUNG, ...

INTERRUPTOR BIPOLAR 4A-250V.
PINES PARA C.I. COTAS DE FIJACION 15mm.



YZ 160 SONY, ...

INTERRUPTOR BIPOLAR 2,5A-250V.
CONTACTO AUXILIAR 1A/24V.
PINES PARA SOLDAR CABLES. COTAS DE FIJACION 23 mm.

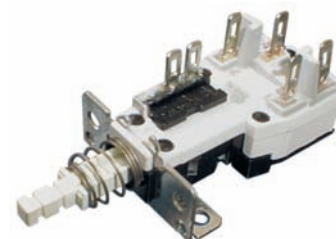

YZ 138 SONY, SHARP, ...

INTERRUPTOR BIPOLAR 2,5A-250V.
CONTACTO AUXILIAR M/D 1A-24V.
PINES PARA SOLDAR CABLES. COTAS DE FIJACION 23mm.

YZ 139 SONY, SHARP, ...

INTERRUPTOR BIPOLAR 2,5A-250V.
CONTACTO AUXILIAR M/D 1A-24V.
PINES PARA SOLDAR CABLES. COTAS DE FIJACION 26mm.

YZ 141 SONY, SHARP, ...

INTERRUPTOR BIPOLAR 2,5A-250V
CONTACTO AUXILIAR M/D.
PINES PARA C.I. COTAS DE FIJACIÓN 20 mm

YZ 141T SONY, SHARP, ...

INTERRUPTOR BIPOLAR 2,5A-250V.
CONTACTO AUXILIAR M/D.
PINES PARA C.I. COTAS DE FIJACIÓN 20 mm.

NO ORIGINAL

YZ 214 SELECO, ...

INTERRUPTOR UNIPOLAR 6A-250V.
DOBLE CONMUTADOR AUXILIAR. FIJACION STANDARD.

YZ 169 CLARIVOX, ...

INTERRUPTOR BIPOLAR 4/80A-250V ~
CONTACTO AUXILIAR M/D.
PINES PARA SOLDAR CABLES. FIJACION ESPECIAL.

YZ 164 THOMSON, ...

INTERRUPTOR BIPOLAR 4/80A-250V ~
CONTACTO AUXILIAR M/D
PINES PARA SOLDAR CABLES. COTAS DE FIJACION 18 mm

YZ 165 SANYO, ...

INTERRUPTOR BIPOLAR 4/80A-250V ~
CONTACTO AUXILIAR M/D.
PINES PARA SOLDAR CABLES. COTAS DE FIJACION 23 mm.

YZ 161 PHILIPS, HITACHI, ...

INTERRUPTOR BIPOLAR 4A-250V.
FIJACION ESPECIAL C.I.

YZ 162 PHILIPS, ...

INTERRUPTOR BIPOLAR 4A-250V.
CONTACTO AUXILIAR. FIJACION ESPECIAL C.I.

PHI 001 MODULO DE CONEXION

MODULO DE CONEXION Y RECEPCION CHASIS MD2.2 1A.

YZ 136 PHILIPS, ...

INTERRUPTOR BIPOLAR 4A-250V.
PINES PARA SOLDAR CABLES. COTAS DE FIJACION 23mm

YZ 155 SONY, ...

INTERRUPTOR BIPOLAR 5A-250V.
DOBLE CONMUTADOR AUXILIAR.
COTAS DE FIJACIÓN 15 mm C.I.

YZ 153 PHILIPS, MIVAR, VESTEL, ...

INTERRUPTOR BIPOLAR
PINES PARA SOLDAR CABLES. COTAS DE FIJACION 18 mm

YZ 142 SONY, SHARP, ...

INTERRUPTOR BIPOLAR 4A-250V.
PINES PARA C.I.. FIJACION ESPECIAL.

YZ 187

INTERRUPTOR BIPOLAR 2,5A/250V.
CONTACTO AUXILIAR M/D
PINES PARA SOLDAR CABLES. COTAS DE FIJACION 20 mm.

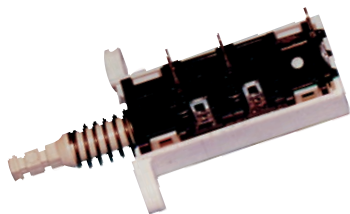

YZ 177

SHARP, SANYO, ...

INTERRUPTOR BIPOLAR 5A-250V.
PINES PARA CABLES Y C.I. COTAS DE FIJACION 20 mm.

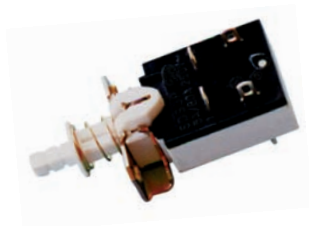

YZ 152

INFORMATICA

INTERRUPTOR BIPOLAR 5/120A-250V CA
PINES CABLES. FIJACIÓN ESPECIAL.



YZ 198

INTERRUPTOR BIPOLAR 4/128A-250V~
PINES PARA C.I. FIJACION ESPECIAL.

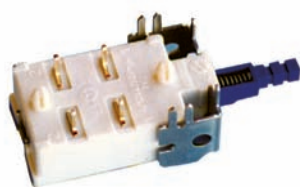

YZ 200

PHILIPS, ...

INTERRUPTOR BIPOLAR 4/120A-250V~
PINES PARA C.I. FIJACION ESPECIAL C.I. PASO 24 mm.

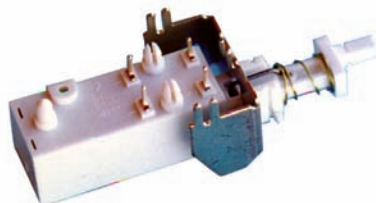

YZ 201

INTERRUPTOR BIPOLAR 5/100A-250V~
CONTACTO AUXILIAR 1A-24V.
PINES PARA SOLDAR. COTAS DE FIJACION 23 mm.



YZ 203

INTERRUPTOR BIPOLAR 5/40A-250V~
PINES PARA SOLDAR. COTAS DE FIJACION 20 mm.

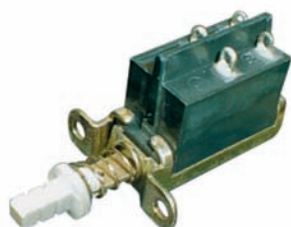

YZ 146

INFORMATICA

INTERRUPTOR BIPOLAR 5/120A-250V CA
PINES CABLES. FIJACIÓN ESPECIAL.

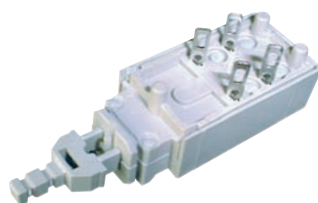

YZ 202

INTERRUPTOR BIPOLAR 5/100A-250V~
CONTACTO AUXILIAR 1A-24V.
PINES PARA C.I.. FIJACION C.I. PASO 20 mm.

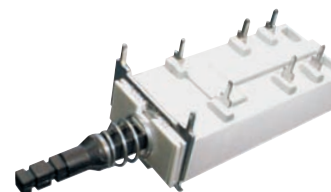

YZ 205

INTERRUPTOR BIPOLAR 5/80A-250V~
CONTACTO AUXILIAR M/D.
PINES PARA C.I.. COTAS DE FIJACION 15 mm.

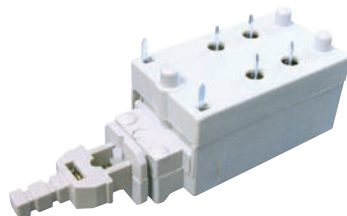

YZ 209

ITT, ...

INTERRUPTOR BIPOLAR 4A-250V.
CONTACTO AUXILIAR M/D.
PINES PARA SOLDAR CABLES. COTAS DE FIJACION 23 mm.

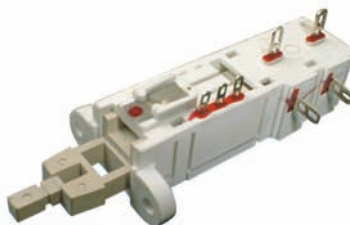

YZ 176

INTERRUPTOR BIPOLAR 4A-250V
PINES PARA SOLDAR CABLES. COTAS DE FIJACION 25 mm.

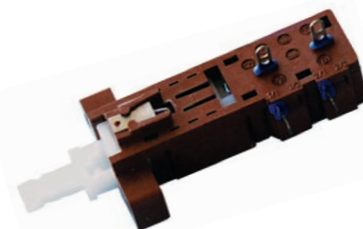

YZ 196

TELEFUNKEN, ...

INTERRUPTOR BIPOLAR 4/120A-250V~
CONTACTO AUXILIAR M/D.
PINES PARA SOLDAR. FIJACIÓN ESPECIAL.

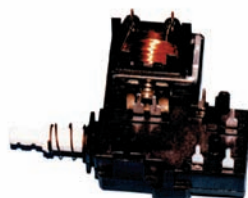

YZ 131

THOMSON, ...

INTERRUPTOR BIPOLAR 4/128A-250V.
CONEXION CONECTOR Y C.I.. COTAS DE FIJACION 18 mm

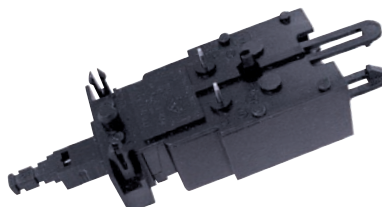

YZ 212

THOMSON, ...

INTERRUPTOR BIPOLAR 4/120A-250V.
CONEXION ESPECIAL (CONECTOR).
COTAS DE FIJACION 18 mm.

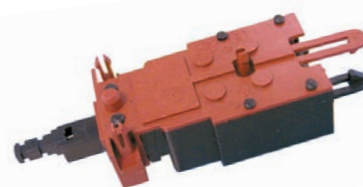

YZ 213 ELBE, ...

INTERRUPTOR CON POTENCIOMETRO 5K



YZ 213-1 ELBE, ...

INTERRUPTOR CON POTENCIOMETRO 10K



YZ 215 SELECO, ...

INTERRUPTOR BIPOLAR 5/120A-250V.
CONTACTO AUXILIAR. COTAS DE FIJACION 15mm.

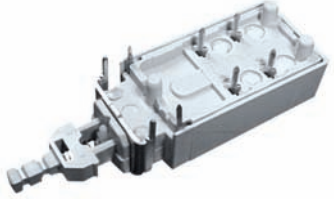

POTENCIOMETROS DE FOCO

PTF 001 POTENCIOMETRO DE FOCO

CHASIS ICC5. GRUNDIG ...

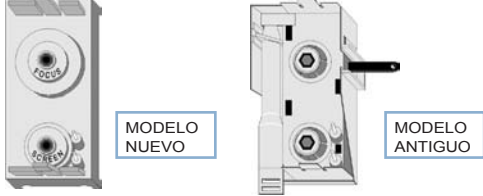
MODELO NUEVO

MODELO ANTIGUO

PTF 002 POTENCIOMETRO DE FOCO

10-500MOhm. 13KV. 2W. THOMSON, PHILIPS, ...



PTF 004 POTENCIOMETRO DE FOCO

22MOhm. PHILIPS K30.

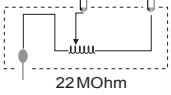
22MOhm

PTF 005 POTENCIOMETRO DE FOCO

100MOhm

A B C D E

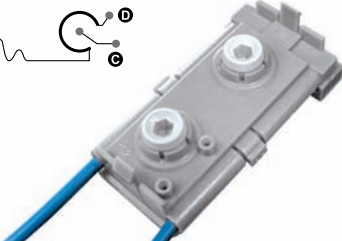
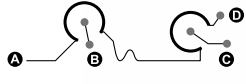
PTF 006 POTENCIOMETRO DE FOCO

120MOhm

A B C D E

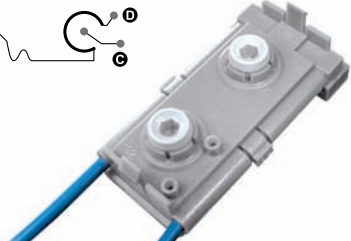
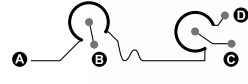
PTF 007 POTENCIOMETRO DE FOCO

35MOhm. PHILIPS K40.

35MOhm

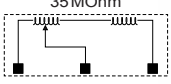
PTF 008 POTENCIOMETRO DE FOCO

ITT, ...

35MOhm 63MOhm

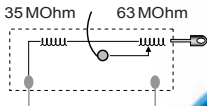
PTF 010 POTENCIOMETRO DE FOCO

NOKIA, ...



ZOCALOS TV

ZTV 001 ZOCALO

CONEXIONES 8 + 1 + 1. PHILIPS



ZTV 002 ZOCALO

CONEXIONES 8 + 1 + 1. SELECO, REX, ...



ZTV 003 ZOCALO

CONEXIONES 7 + 1 + 1. S 825/16.



ZTV 004 ZOCALO

CONEXIONES 7 + 2. S 800/805 PIL.

